

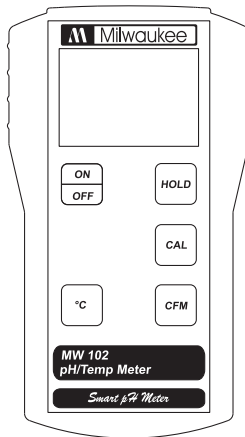

USER MANUAL

PORTABLE uP-BASED pH METER MODEL: MW102

Smart pH Meter



WARRANTY:

This instrument is warranted from all defects in materials and manufacturing for a period of **two years** from the date of purchase.

The **electrode is warranted for a period of six months.**

If during this period the repair or replacement of parts is required, where the damage is not due to negligence or erroneous operation by the user, please return the parts to either distributor or our office and the repair will be effected free of charge.

Note: We reserve the right to modify the design, construction and appearance of our products without advance notice.



OPERATION:

- The meter is supplied complete with a 9V battery. Slide off the battery compartment cover on the back of the meter and install the battery into battery clip connector while observing polarity.
- Always remove the electrode protective cap before taking any measurement. If the electrode has been left dry, soak the tip (bottom 2.5 cm) in rinse solution (**M1000B**) for a few minutes to reactivate it.
- Connect the pH electrode and the temperature probe to the sockets on the meter's top. The temperature probe can be used independently to take temperature measurements, or it can be used in conjunction with the pH electrode to utilize the meter's ATC capability.
- Turn the instrument on by pressing the ON/OFF key.
- Before taking any measurements, make sure that the meter has already been calibrated.
- Immerse the tip (2.5 cm) of the pH electrode and the temperature probe into the sample and stir gently.
- The pH measurement is ready when the hourglass symbol stops blinking.
- To display the measured temperature, press and hold the °C key. When the key is released, the display will return to the pH reading.

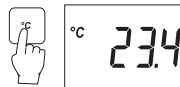
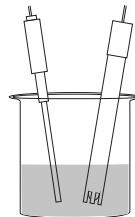
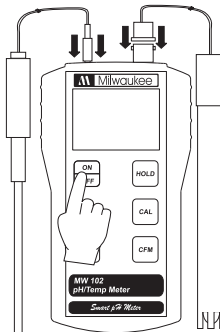

- The HOLD function is activated by pressing the HOLD key. The measured value is frozen on the display and the "HOLD" tag lights up. Release "HOLD" by pressing HOLD key again.
- After completing measurements, switch the meter off and store the electrode with a few drops of storage solution in the protective cap.
- Error message on display:
 - Blinking full scale value: reading is over range;
 - "Eb": battery low voltage indication;
 - "Ec": wrong buffer solution;
 - "Clr": the calibration data have been lost and recalibration is needed.



CALIBRATION PROCEDURE:

A) Preparation:

Select two pH calibration buffers: pH 7.01 and a second to bracket your measurement range.

1. **pH 7.01 (MA9007)**
2. **pH 4.01 (MA9004)** for measuring in the acid range (pH lower than 7) or **pH 10.01 (MA9010)** for measuring in the alkaline range (pH higher than 7).

Use two beakers for each reference solution. One beaker for rinsing the electrode, the other for calibration. This way contamination between solutions during calibration is minimized.

B) Procedure:

Offset calibration

- Remove the electrode protective cap and rinse the tip with some pH 7.01 solution, then immerse the electrode tip and the temperature probe into a pH 7.01 buffer solution.
- Press the CAL key to enter the Calibration mode. The display flashes "pH 7.01" and the hourglass lights up.



- Wait till the hourglass symbol on the display turns off and the “pH” tag stops blinking, then press the CFM key to confirm the offset calibration. 

Note: Pressing the CAL key again will change the buffer value, allowing a single point calibration at pH 4.01 or pH 10.01.

Slope calibration

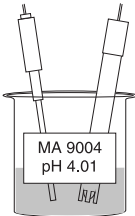
- After completing the pH 7.01 calibration the next buffer pH 4.01 will flash on the display.
- Press CAL key to display pH 10.01 if desired.
- Rinse the pH electrode and the temperature probe in the rinse buffer beaker, then immerse them into the second buffer beaker. 
- Wait till the hourglass symbol on the LCD turns off, then press the CFM key to confirm the slope calibration.

Notes:

- To exit the calibration mode, turn the meter off by pressing the ON/OFF key.
- To perform a single point calibration (offset) at pH 7.01, press the ON/OFF key when the second buffer is displayed.
- After battery replacement, the meter displays the “Clr” message and recalibration is needed.

BATTERY REPLACEMENT:

When the battery becomes weak a reliable measurement can not be guaranteed. The meter will display “Eb” for a while and then turn off.

Prompt battery replacement is required.

Battery replacement must only take place in a non-hazardous area using a 9V alkaline battery.

Turn the meter off, slide the battery compartment cover located at the rear of the meter off and replace the 9V battery with a new one.

Make sure the battery contacts are fully engaged in the connector, seat the battery in its compartment and replace the cover.

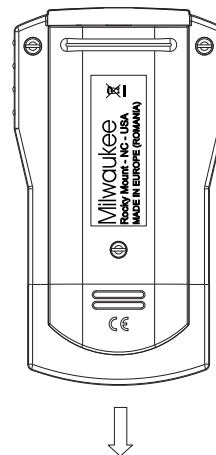

OPTIONAL ACCESSORIES:

MA 9004	pH4.01 buffer solution, 220 mL bottle
MA 9007	pH7.01 buffer solution, 220 mL bottle
MA 9010	pH10.01 buffer solution, 220 mL bottle
MA 9015	Electrode storage solution, 220 mL bottle
MA 9016	General cleaning solution, 220 mL bottle
M10000B	Rinse solution, 20 mL sachet (25 pcs.)
MA 911B/1	pH electrode with BNC connector and 1 m cable
MA 830R	Temperature probe
MA 950	Portable meter wall mounting kit

SPECIFICATIONS:

MW102

RANGE	-2.00 to 16.00 pH -5 to 70°C
RESOLUTION	0.01 pH / 0.1°C
ACCURACY (@25°C)	±0.02 pH / ±0.5°C
TYPICAL EMC DEV.	±0.02 pH / ±0.5°C
TEMPERATURE COMPENSATION	Automatic, 0 to 70°C
CALIBRATION	Automatic, at 1 or 2 points
pH ELECTRODE	MA911B/1 (included)
TEMPERATURE PROBE	MA830R (included)
ENVIRONMENT	0 to 50°C; RH 95% max.
BATTERY TYPE	1 x 9V alkaline (included)
BATTERY LIFE	approx. 750 hours of use
AUTO-OFF	after 8 minutes of non-use
DIMENSIONS	143 x 80 x 32 mm
WEIGHT	220 g (with battery)